

Application Note

Exterior Noise Measurements on a Rover 220 GSi

by Nigel Taylor, Rover Group, UK and Per Rasmussen, Brüel & Kjær, Denmark

The acceptable exterior noise level from passenger cars is constantly decreasing through national and international regulations. Most recently, the acceptable level within the European Union has been lowered to 74 dB(A). To fulfill these demands, still more advanced measuring techniques have to be used in the development process and for troubleshooting.

In this example, traditional measuring techniques suggested that the main noise source was the exhaust orifice. Detailed analysis of the sound field using Spatial Transformation of Sound Fields showed that the engine air intake system was dominant. As a result the overall sound pressure level was reduced by minor adjustments to the intake system as opposed to major modifications to the exhaust system.

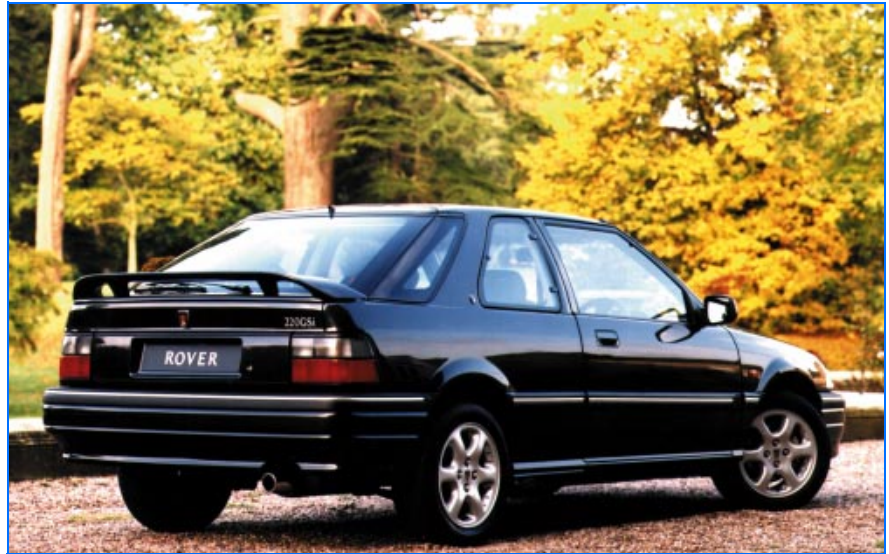

Introduction

The increased demand for lower noise emission from cars and trucks, especially from new European regulations, has emphasized the need for a very detailed knowledge of the individual noise sources and the influence they have on the overall noise radiation. Exterior vehicle noise is normally measured following the procedure in ISO standard 362 "Acoustics – Measurement of noise emitted by accelerating road vehicles – Engineering method" [1]. According to this standard, the noise is measured with a microphone placed 7.5 m from the centre of the test road. The vehicle is accelerated past the microphone at full throttle and the registered noise level is the maximum level measured during the pass-by.

This measuring procedure was primarily developed to give a single number rating of the noise emission of the car. However, in order to reduce this exterior noise in the most efficient way, it is essential to have de-

tailed information about the vehicle's individual noise sources. This includes information about the locations of the individual sound sources, the strength of each source and the interaction between the different sources. To obtain this information, it is necessary to measure in the acoustic near-field of the car.

The ISO 362 procedure is not suited for, and not intended for, such detailed investigations of the different noise sources. As the microphone is placed 7.5 m away from the centre of the test road, it is essentially a far-field measurement, which gives very little information about the acoustic near-field. The distance from the different parts of the vehicle to the microphone is almost the same, so seen from the microphone position the car is one big source with a complicated directivity pattern. At higher frequencies where the wavelength of the sound is much smaller than the dimensions of the car and the distance from the car to the microphone, the individual noise sources can be considered as simple omni-directional

monopoles radiating equally in all directions. However, the shape of the enclosures (e.g. engine bay) and acoustic trim can result in directional noise sources. At lower frequencies, especially around the dominating engine noise frequencies, where the wavelengths are comparable to the dimensions of the car, correlated noise sources will interact and can result in complicated directivity patterns.

To study the individual noise sources and their interactions, it is necessary to have detailed information about the acoustic near-field. The Spatial Transformation of Sound Fields (STSF) technique gives full information about both the near-field and the far-field so that the precise relationship between the different noise sources, identified in the near-field, and the resulting far-field pressure level can be determined. It is thereby possible to concentrate the noise reduction efforts on the near-field noise sources which contribute most to the far-field sound pressure level.

Pass-by Noise Measurements

The Rover 220 GSi was tested on the Rover Gaydon test site, on the ISO 10844 [2] Standard noise test road surface. The vehicle was tested in both 2nd and 3rd gear, according to the procedure in ISO 362 standard. The pass-by noise level in 2nd gear was successfully reduced using, among other things, a finite element model of the exhaust system. The result of a test in third gear is shown in Fig. 1. This gives the overall A-weighted sound pressure level as a function of the vehicle position relative to the microphones. The maximum SPL on the left and right side of the vehicle is 73 dB(A) and 75 dB(A) respectively. A further frequency analysis shows that the overall SPL is dominated by noise in the 100 Hz 1/3-octave band, which corresponds to the engine firing frequency or second harmonic of the engine revolution. The maximum SPL occurred when the car was approximately 8 m past the microphones, at which point the speed was 59 km/hr.

As part of an overall noise study on the Rover 220 GSi, the engine related noise around 100 Hz was studied in detail on the rolling road in the Vehicle Semi-Anechoic Chamber at Rover's Gaydon site using STSF.

STSF Measurements

The basic principle of STSF is to measure cross spectra of sound pressure over a plane close to the measuring object. In this case a pressure microphone array, Fig. 2, was scanned along the right side of the

car and the full sound field was measured with a spatial resolution of 0.225 m. In each scan position the cross spectra between the scan microphone and a set of fixed reference microphones were measured with a multichannel FFT analyzer. These measurements resulted in a complete description of the sound field where both phase and magnitude are known at all points. By using mathematical calculation techniques like Helmholtz' Integral Equation and Near-field Acoustical Holography [3], it was then possible to calculate all acoustic parameters like sound intensity distribution, particle velocities, radiation pattern, etc. In addition, it

was, for example, also possible to simulate changes to the original sound source and predict the resulting far-field sound pressure level.

During the STSF measurement, the car was driving at full load at 59 km/hr corresponding to the condition where the maximum level occurred during the pass-by test. In order to obtain a full description of the sound field over the full scan plane, it is necessary that the sound source is stationary (constant) during the full measurement. This means that some differences in the measurements obtained during the pass-by test and the STSF are to be expected.

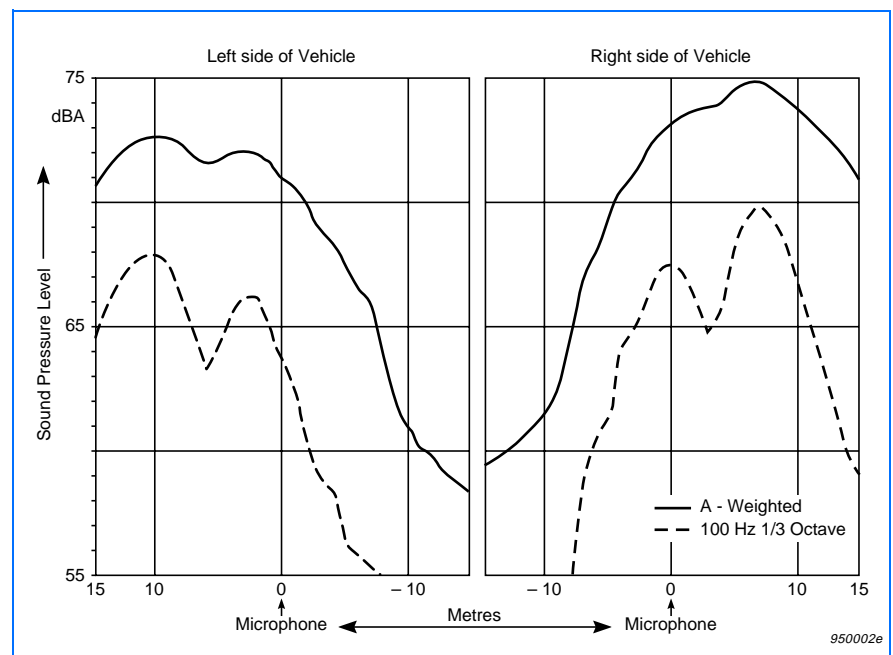

Fig.1 SPL versus vehicle position for passby

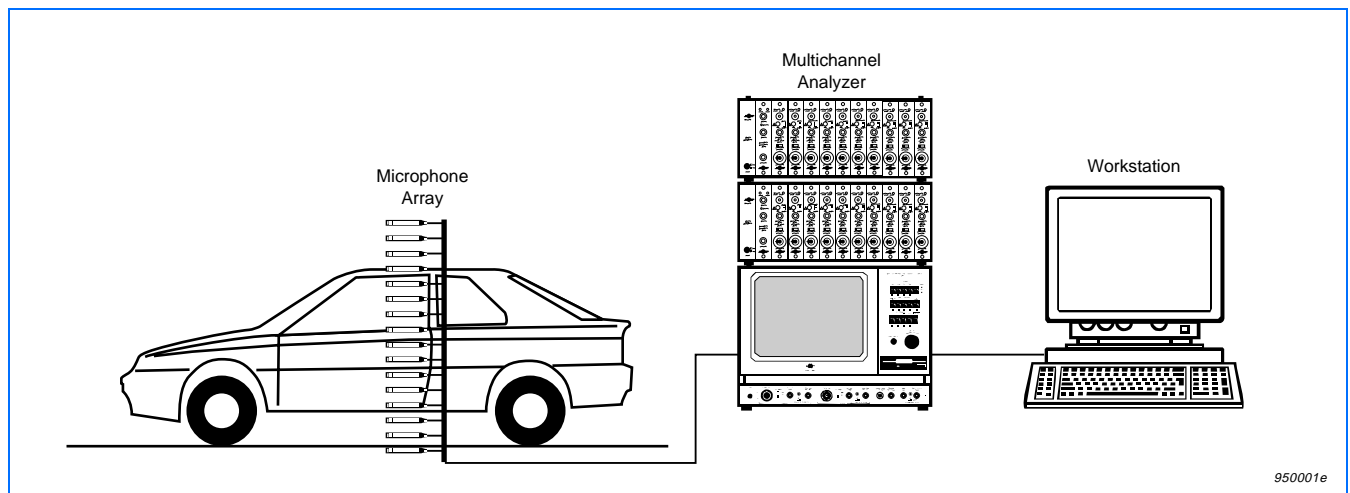

Fig.2 STSF Measurement set-up

Results

The measurements result in a mathematical description of the sound field from which the radiation can be calculated. Fig. 3 shows the calculated SPL in the far-field calculated from the STSF measurements in the near-field. This gives the sound pressure level at 100 Hz along a line 7.5 m from the centerline of the car at a height of 1.2 m corresponding to the measurement position used during the actual pass-by test. It can be seen that the SPL has two maxima, one around 2.10 m behind the center of the car and one 4.5 m in front of the car center line. The absolute levels are slightly higher than the levels obtained during the pass-by test, but the trend is the same. Intuitively, the highest peak occurring at the rear of the car could be associated with the noise radiated from the exhaust orifice and the smaller peak could be associated with the air intake orifice. This is in contradiction with the sound intensity distribution in the near-field, Fig. 4, also calculated from the STSF data. This shows the radiated intensity right on the surface of the car. Here it can clearly be seen that the dominant noise source is the air intake orifice and not the exhaust orifice. This apparent conflict between the far-field measurement and the near-field measurement is caused by the fact that the exhaust and intake noise are correlated sources and, as such, interfere with each other. This can be seen from a calculation of the intensity radiation away from the car towards the line used for the far-field calculations. Fig. 5 shows the intensity vectors away from the exhaust orifice and the intake orifice. Two “beams” can be identified: one

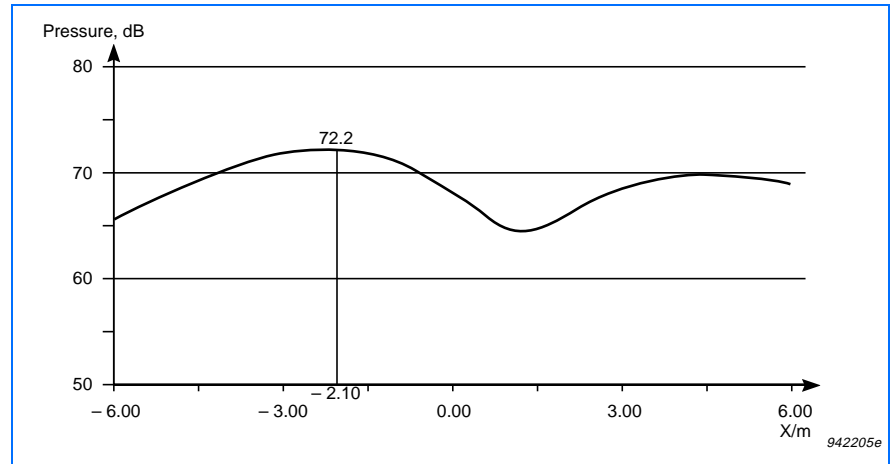

Fig. 3 STSF simulated pass-by measurement, 100 Hz

away from the exhaust and one away from the intake. Around 1 – 2 m away from the car the sound energy from the two sources interacts. The result is a higher sound pressure level towards the rear of the car.

Simulation

The overall SPL of the car can be reduced by either reducing the noise from the exhaust orifice or by reducing the noise from the intake orifice. These two cases were simulated with the STSF Source Attenuation technique and the far-field SPL result was calculated.

The reduction of the noise from the exhaust orifice was simulated by introducing a 3 dB attenuation function in the mathematical STSF model of the area around the exhaust orifice. From this new acoustic model of the

near-field, the resulting acoustic far-field was calculated, giving the result shown in Fig. 6. By comparison with the original result in Fig. 3, it can be seen that a reduction of the exhaust noise by 3 dB only reduces the overall maximum SPL by 0.9 dB. Similarly, the effect of reducing the noise from the intake was simulated by applying a 3 dB attenuation function to the area around the intake orifice. The far-field calculations, Fig. 7, show that this results in a reduction of the overall maximum SPL by 1.8 dB. It can therefore be concluded that a reduction of the intake noise has a greater effect on the overall SPL than a similar reduction of the exhaust noise. This is also in agreement with the results from the near-field calculations, which showed that the major contribution to the far-field SPL was coming from the intake.

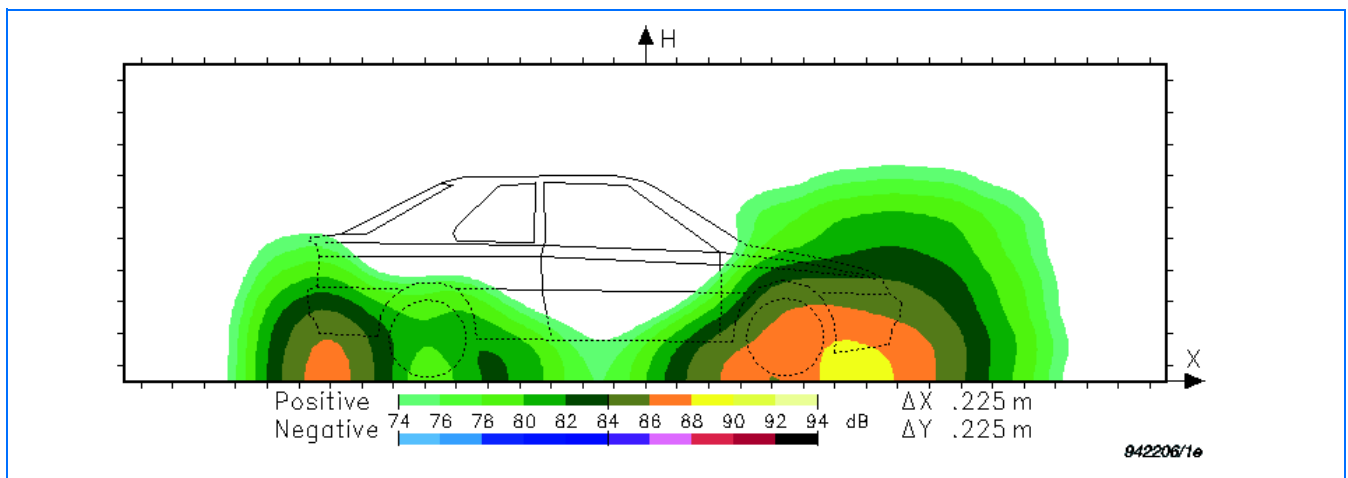
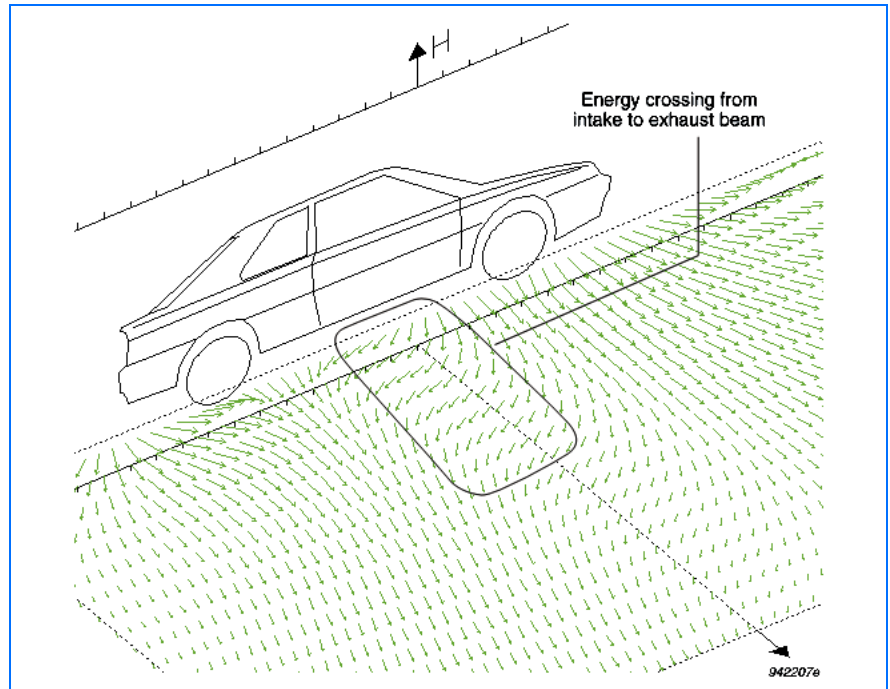

Fig. 4 Intensity radiation from right side

Fig.5 Intensity radiation away from vehicle



Conclusion

Originally the Rover 220 GSi meets the 77 dB(A) European limit for exterior noise from passenger cars. Based on pass-by noise measurements, finite element modelling and STSF measurements the vehicle was modified to meet the new 74 dB(A) limit coming into effect from 1995.

The exterior noise was studied in detail using STSF techniques, resulting in a complete mathematical model of both the near-field and far-field acoustical radiation. This made it possible to determine the complicated radiation pattern at low frequencies and thereby identify the major noise sources. The interaction of the different sound sources was identified and the resulting directivity pattern of the car was calculated. By simulating different noise source reductions, it was possible to predict the result in the far-field and thereby select the optimum noise reduction strategy.

Fig.6 Simulated pass-by noise with exhaust noise attenuation

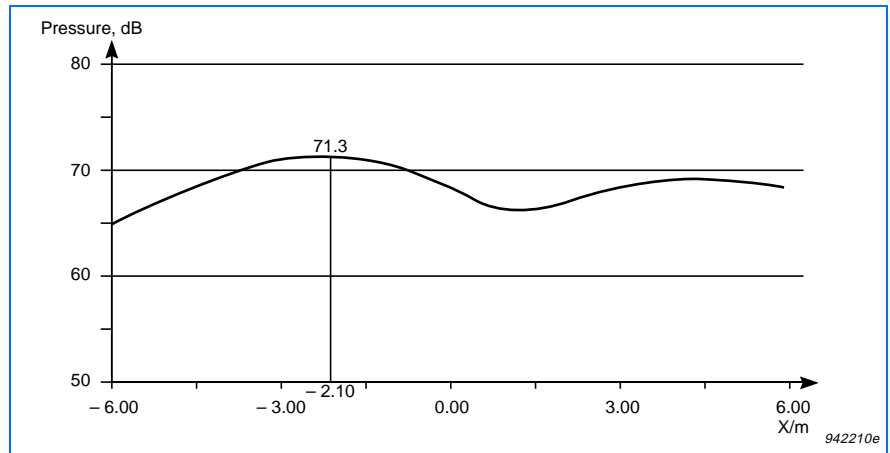

References

- [1] International Standards Organization 362-1982(E): "Acoustics – Measurement of noise emitted by accelerating road vehicles – Engineering method"
- [2] International Standards Organization 10844: "Acoustics – Test surface for road vehicles noise measurements"
- [3] J.Hald: "STSF – a unique technique for scan-based Near-field Acoustic Holography without restrictions on coherence", Brüel & Kjær Technical Review No. 1 (1989) BV0035

Fig.7 Simulated pass-by noise with intake noise attenuation

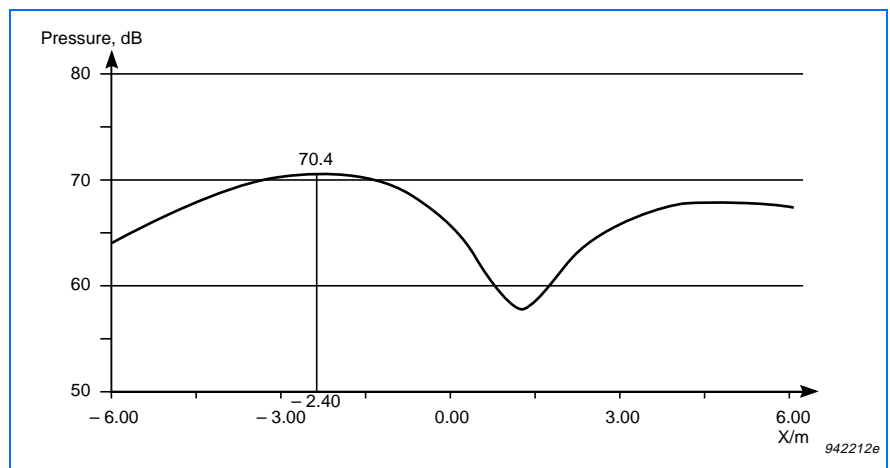

Brüel & Kjær 

WORLD HEADQUARTERS:

DK-2850 Naerum · Denmark · Telephone: +45 45 80 05 00 · Fax: +45 45 80 14 05 · Internet: <http://www.bk.dk> · e-mail: info@bk.dk

Australia (02) 9450-2066 · Austria 00 43-1-865 74 00 · Belgium 016/44 92 25 · Brazil (011) 246-8166 · Canada: (514) 695-8225 · China 10 6841 9625 / 10 6843 7426

Czech Republic 02-67 021100 · Finland 90-229 3021 · France (01) 69 90 69 00 · Germany 0610 3/908-5 · Holland (0)30 6039994 · Hong Kong 254 8 7486

Hungary (1) 215 83 05 · Italy (02) 57 60 4141 · Japan 03-3779-8671 · Republic of Korea (02) 3473-0605 · Norway 66 90 4410 · Poland (0-22) 40 93 92 · Portugal (1) 47114 53

Singapore (65) 275-8816 · Slovak Republic 07-37 6181 · Spain (91) 36810 00 · Sweden (08) 71127 30 · Switzerland 01/94 0 09 09 · Taiwan (02) 713 9303

United Kingdom and Ireland (0181) 954-236 6 · USA 1 - 800 - 332 - 2040

Local representatives and service organisations worldwide

RO 0430 - 11